

Article number: 20240835610GG

Description: E+G Telescope-Liאר motion bearings GN 2408-35-610-GG

Measures

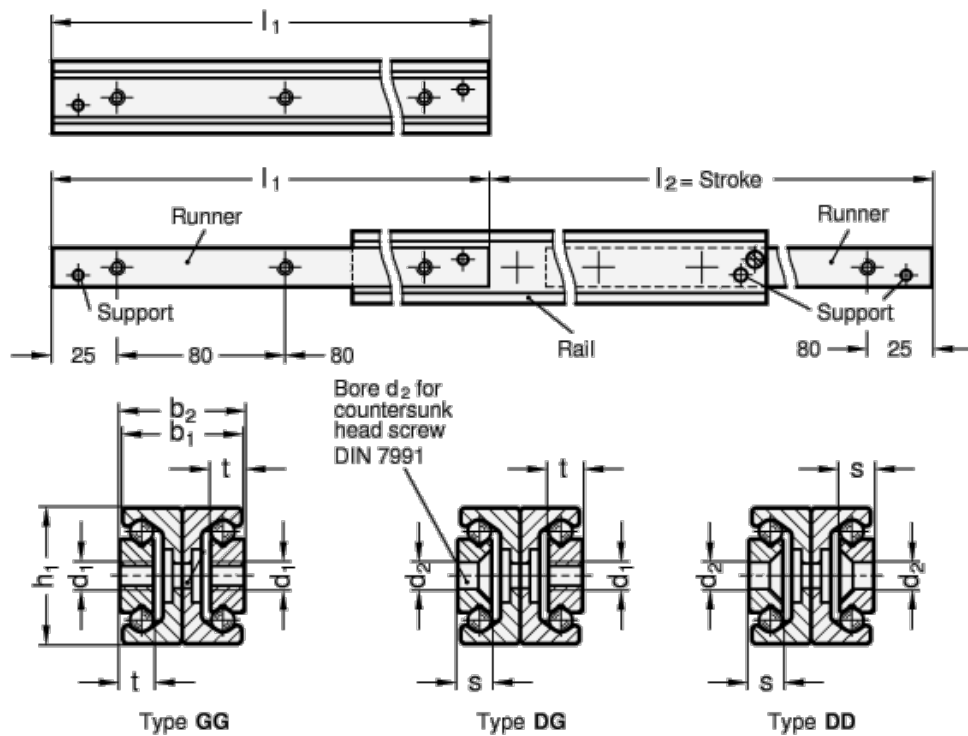

$b_1 = 33$
 $b_2 = 34$
 $d_1 = M6$
 $d_2 =$
 $h_1 = 35$
 $L_1 = 610 - 464$
 $s =$
 $t = 10$

Weight in (g) = 3720